

Brass Mailboxes



2030RL



2016RL



2014RL



BRASS MAILBOXES PRIVATE ACCESS REAR OR FRONT LOADING

Salsbury 2000 series brass mailboxes have solid brass die-cast doors which include a five (5) pin cylinder cam lock with two (2) keys, a clear 1/4" glass window and a name plate to identify the tenant's name and/or box number. The doors are hinged on brass frames and are attached to the individual compartments with four (4) screws. The mailbox compartments are constructed of 20 gauge steel and powder coated tan. They are designed to stack two (2) high and mount adjacent to each other or between wall studs. All units have the same outside dimensions. Rear loading units can be accessed by the U.S.P.S. when used in Rotary Mail Centers (see page 24).

If Rear Loading:

Units have open backs. Locking rear covers (#2050) are available as an option upon request.

If Front Loading:

Units include solid rear covers. Two (2) master commercial locks with two (2) keys (#2092) open a door panel that swings on a continuous hinge. All openings are usable.

2000 Series Door Sizes

Solid brass replacement doors include frame and lock with two (2) keys.

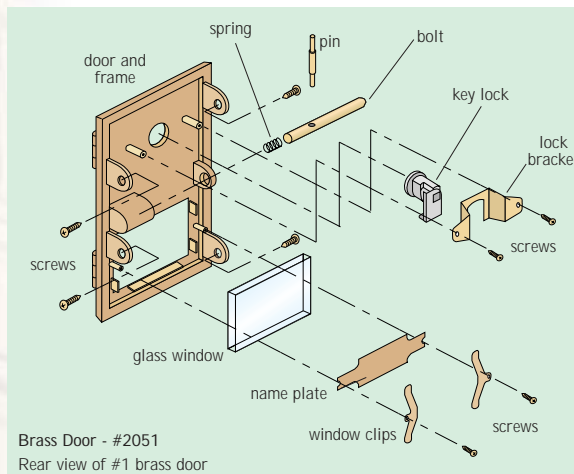

#2051
Replacement
door \$20.00

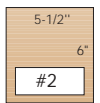

#2052
Replacement
door \$30.00

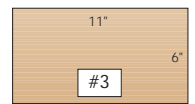

#2053
Replacement



2008RL



Sample Front Loading (FL) Unit

Sample Installation

Models displayed:
(3) 2030RL's
(3) 2014RL's

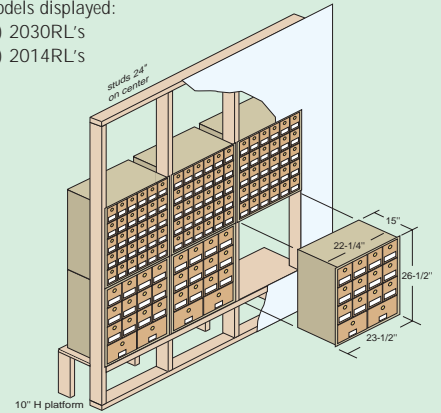

Allow approximately 24" W and 53" H for each mailbox column.



BRASS MAILBOX OPTIONS

OPTIONS

- Custom sized mailbox units - call for pricing
- Plastic windows - eliminates compartment visibility
 - #1 and #3 door size (#2071 - \$1.75)
 - #2 door size (#2073 - \$2.00)
- Rear covers - locking on rear loading units (#2050 - \$50.00)
- Trim - tan snap-on peripheral trim
 - 1-1/2" W x 3/8" D for up to (3) columns of mailboxes (#2013 - \$80.00)

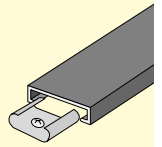

#2013 Trim \$80.00

DOOR AND COMPARTMENT IDENTIFICATION

Each mailbox door is equipped to identify the tenant's name and/or box number. Self-adhesive numbers (1-3000 available) are supplied upon request with a standard order. Custom identification systems are available as an option upon request. Label holders neatly organize and identify the front/rear of the mailbox compartments and are available as an option upon request.

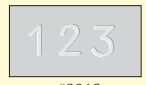

#2068 Window engraving \$3.00

- Custom window engraving - plastic windows only (#2068 - \$3.00)
- Self-adhesive numbers - sheets of (100) (#2095 - \$15.00)
- Label holders - (50) 3" W x 3/8" H (#1070 - \$30.00)



#1070 Label holders (50) \$30.00

LOCKS

Each mailbox door includes a five (5) pin cylinder cam lock with two (2) keys (1,000 different key changes).

- Lock - for 2000 series (#2090 - \$5.00)
- Three (3) digit single dial combination lock with spring latch and automatic throw-off (combination numbers can be changed by owner) Not available on #3 doors (#2086 - \$8.00)
- Thumb latch - in lieu of standard lock (#2089 - \$3.00)
- Lock - front loading master (#2092 - \$7.00) not pictured
- Upgraded lock for 2000 series with (3) keys (#2090U - \$9.00)
- Additional keys per lock (#2090) when ordering (#2098 - \$2.00)
- Key blanks - box of (50) - for 2000 series (#2099 - \$25.00)
- Key blanks - box of (50) - for #2090U (#2099U - \$30.00)

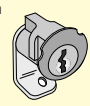

#2090 Lock for 2000 series \$5.00

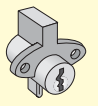

#2090U Upgraded lock for 2000 series \$9.00

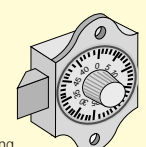

#2086 Combination lock for 2000 series (n/a on #3 doors) \$8.00



#2089 Thumb latch for 2000 series \$3.00

BRASS MAILBOXES - REAR OR FRONT LOADING

MODEL	DESCRIPTION	DOOR SIZE	WEIGHT	PRICE
REAR LOADING				
2030RL	30 Doors	3-1/2" W x 5" H	105 lbs.	\$580.00
2016RL	16 Doors	5-1/2" W x 6" H	90 lbs.	\$540.00
2014RL	14 Doors	(12) 5-1/2" W x 6" H (2) 11" W x 6" H	90 lbs.	\$540.00
2008RL	8 Doors	11" W x 6" H	90 lbs.	\$540.00
UNIT SIZE				
23-1/2" W x 26-1/2" H x 15" D				
FRONT LOADING				
2030FL	30 Doors	3-1/2" W x 5" H	115 lbs.	\$680.00
2016FL	16 Doors	5-1/2" W x 6" H	100 lbs.	\$640.00
2014FL	14 Doors	(12) 5-1/2" W x 6" H (2) 11" W x 6" H	100 lbs.	\$640.00
2008FL	8 Doors	11" W x 6" H	100 lbs.	\$640.00
UNIT SIZE				
23-1/2" W x 26-1/2" H x 16" D				
2086	Lock - combination for each 2000 series door			\$8.00
2090	Lock - standard replacement for 2000 series doors - with (2) keys			\$5.00
2099	Key blanks - for standard 2000 series locks - box of (50)			\$25.00

