











Fashion Bed Group

A Division of Leggett & Platt Incorporated
5950 West 51st Street - Chicago, IL 60638

Parts List For Deco Bed

BED CARTON	HEADBOARD CARTON				
<p>(9) HEADBOARD PANEL (10) FOOTBOARD PANEL</p> <p>PART #363801 HARDWARE BAG FOR FRAME ATTACHMENT</p> <p>(1) 1/4-20 X 2" COUNTERSUNK ALLEN ALLEN HEAD SCREW-4 (2) 1/4-20 X 1" FLAT ALLEN HEAD SCREW -4 (3) 5/8" (OD) FLAT METAL WASHER - 8 (4) 1/4" (ID) LOCK METAL WASHER - 8 (5) 1/4 - 20 HEX NUTS - 4 (6) ALLEN WRECH- 1 (7) OPEN END WRENCH -1</p> <p>(8) LEG. EXTENSIONS - 2 # 363803 PLASTIC GLIDES - 4 # 363804</p> <p>NOTE: GLIDES COME PRE-INSERTED</p>	<p>(9) HEADBOARD PANEL</p> <p>PART #363802 HARDWARE BAG FOR FRAME ATTACHMENT</p> <p>(1) 1/4-20 X 2" COUNTERSUNK ALLEN ALLEN HEAD SCREW-4 (3) 5/8" (OD) FLAT METAL WASHER - 4 (4) 1/4" (ID) LOCK METAL WASHER - 4 (5) 1/4 - 20 HEX NUTS - 4 (6) ALLEN WRECH- 1 (7) OPEN END WRENCH -1</p> <p>(8) LEG. EXTENSIONS - 2 # 363803 PLASTIC GLIDES - 4 # 363804</p> <p>NOTE: GLIDES COME PRE-INSERTED</p>	<p>1</p> 	<p>2</p> 	<p>3</p> 	<p>4</p> 
		<p>5</p> 	<p>6</p> 	<p>7</p> 	
		<p>8</p> 		<p>9</p> 	
		<p>10</p> 			

PRODUCT FULLY ASSEMBLED

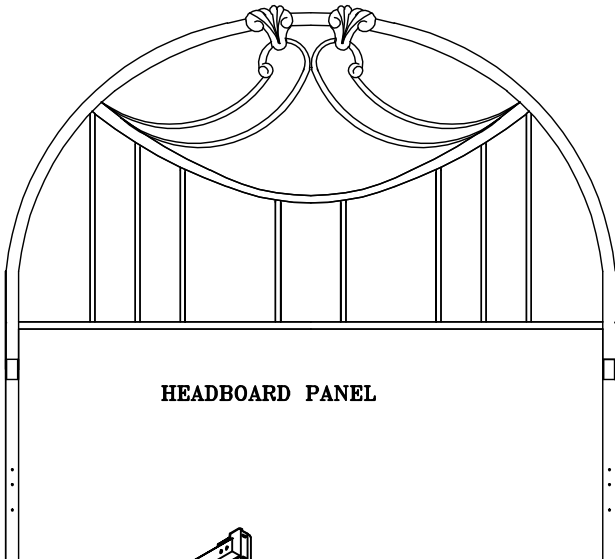

HEADBOARD PANEL

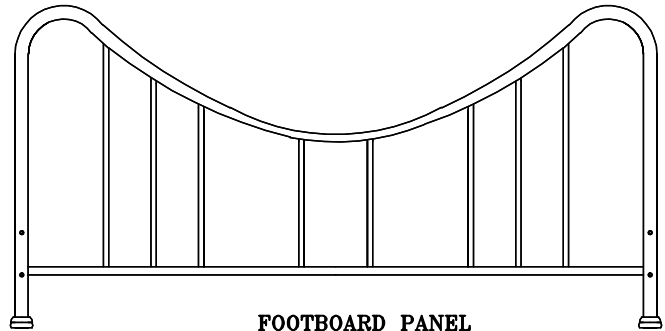

FOOTBOARD PANEL

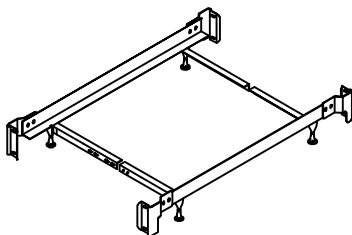

TWIN - FULL BED FRAME FULLY ASSEMBLED

NOTE: SEE INSTRUCTIONS INCLUDED IN FRAME CARTON FOR FRAME ASSEMBLY

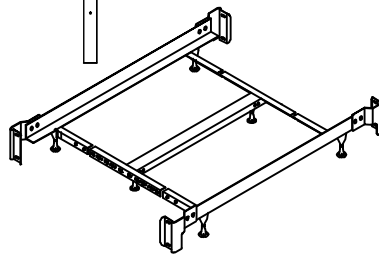

QUEEN - KING BED FRAME FULLY ASSEMBLED

NOTE: SEE INSTRUCTIONS INCLUDED IN FRAME CARTON FOR FRAME ASSEMBLY

FOR ASSISTANCE IN ASSEMBLY ONLY OF THIS PRODUCT. CALL OUR HELP DESK AT 1-800-324-3415, BETWEEN 8:30 AM & 4:30 PM CENTRAL TIME MONDAY THRU FRIDAY. PLEASE HAVE THE STYLE NUMBER AVAILABLE BEFORE YOU CALL. (STYLE # OR NAME CAN BE FOUND ON PACKING CARTON OR SALES RECEIPT.) OUR PRODUCT IS INSPECTED TO ENSURE IT IS IN GOOD CONDITION. IF YOUR FURNITURE APPEARS TO HAVE BEEN DAMAGED IN SHIPMENT OR YOU ARE IN NEED OF REPLACEMENT PARTS PLEASE CONTACT THE DEALER FROM WHOM YOU PURCHASED THE PRODUCT.

Instruction Sheet

SAVE ALL PACKAGING MATERIALS UNTIL PRODUCT IS FULLY ASSEMBLED. HARDWARE AND SMALL PIECES MAY NOT BE SEEN AND BE ACCIDENTALLY DISCARDED WITH PACKAGING MATERIALS.

FIGURE 2

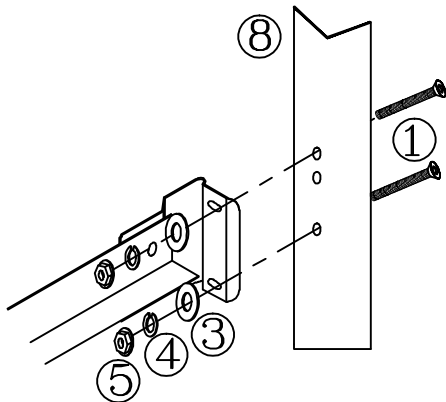
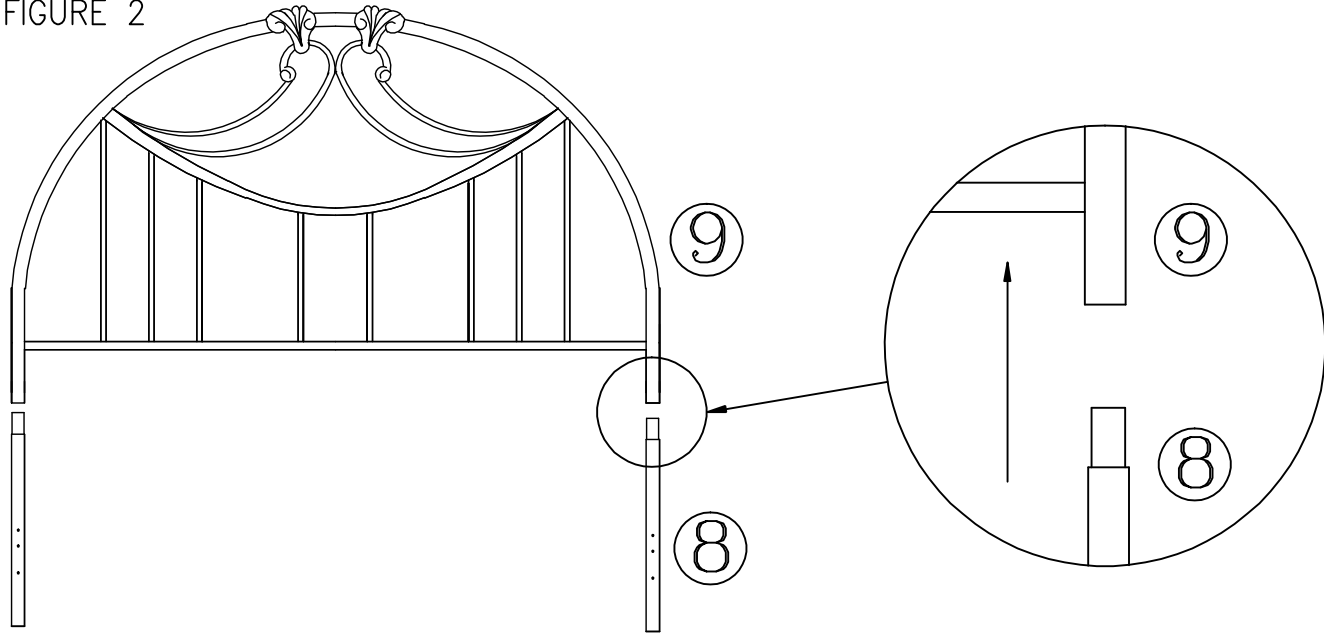

FIGURE 2

Step 1

- Align top reduction of extension legs (8) with bottom of headboard posts (9). (See Figure 1) Make sure the 3 holes on extension legs are perpendicular to headboard panel.
- Now carefully insert extension legs (8) into bottom of headboard post panel (9).

Step 2

- Place headboard and frame in desired location in room.
- Place 2 screws (1) through holes located in leg (8) (See Figure 2)
- Align bed frame bracket over screws.
- Place a flat metal washer (3) and lock washer (4) and then a nut (5) over on each screw. Hand-tighten, DO NOT TIGHTEN screws all the way. (See Figure 2)
- Repeat on other side of headboard.
- Tighten all screws securely using the Allen wrench (6) and open wrench (7).

Step 3

- Position footboard panel (10) and align holes in the post with holes in the frame bracket. (See figure 3)
- Place a lock washer (4) and a flat washer (3) over on each screw (2). Insert through bracket and into post. Hand-tighten, DO NOT TIGHTEN screws all the way.
- Repeat on other side of footboard panel.
- Tighten all screws securely using the Allen wrench (6).

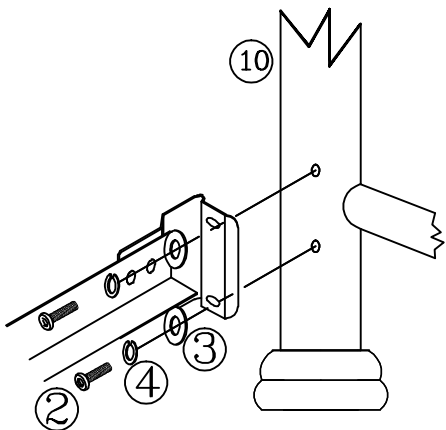

FIGURE 3