

Fashion Bed Group

A Division of Leggett & Platt Incorporated
5950 West 51st Street - Chicago, IL 60638













Parts List For Dynasty Bed

BED CARTON

- (13) HEADBOARD PANEL
- (14) FOOTBOARD PANEL

PART #305201 HARDWARE BAG FOR BED ATTACHMENT TO FRAME

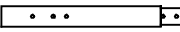
- (1) 1/4-20 2 1/4" COUNTER SUNK ALLEN HEAD SCREW-4
- (2) 1/4-20 1" FLAT ALLEN HEAD SCREW-4
- (3) 1/4-20 1/2" FLAT ALLEN HEAD SCREW-4
- (4) 1/4-20 HEX NUT-4
- (5) 5/8" OD FLAT WASHER-8
- (6) 1/4" ID LOCK WASHER-8
- (7) 7/8" OD RUBBER WASHER-8
- (8) ALLEN WRENCH
- (9) OPEN WRENCH
- (10) PLASTIC GLIDE-4
- (11) FINIAL-4
- (12) LEG EXTENSION-2

1 	2 	3 	4 
5 	6 	7 	8 
9 	10 	11 	
12 	13 		
14 			

PRODUCT FULLY ASSEMBLED

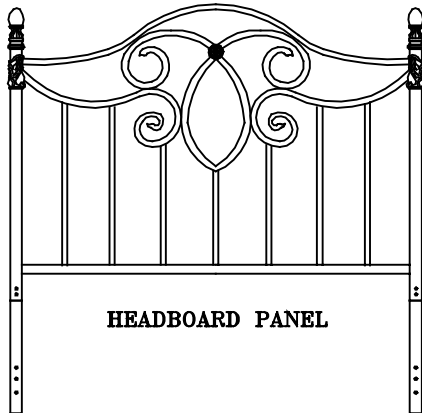

HEADBOARD PANEL

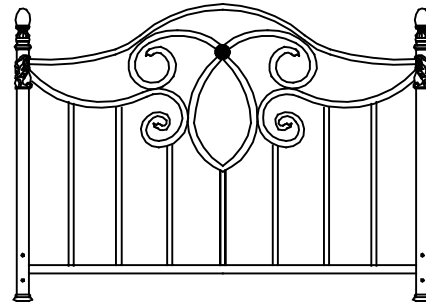

FOOTBOARD PANEL

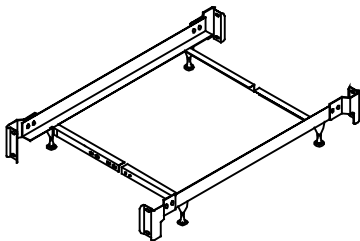

TWIN - FULL BED FRAME FULLY ASSEMBLED
NOTE: SEE INSTRUCTIONS INCLUDED IN FRAME CARTON FOR FRAME ASSEMBLY

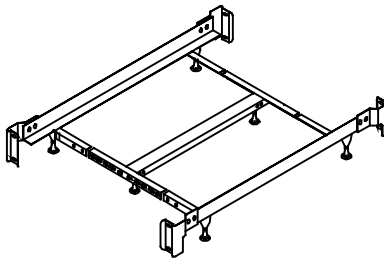

QUEEN - KING BED FRAME FULLY ASSEMBLED
NOTE: SEE INSTRUCTIONS INCLUDED IN FRAME CARTON FOR FRAME ASSEMBLY

FOR ASSISTANCE IN ASSEMBLY ONLY OF THIS PRODUCT. CALL OUR HELP DESK AT 1-800-324-3415, BETWEEN 8:30 AM & 4:30 PM CENTRAL TIME MONDAY THRU FRIDAY. PLEASE HAVE THE STYLE # OR NAME AVAILABLE BEFORE YOU CALL. (STYLE # OR NAME CAN BE FOUND ON PACKING CARTON OR SALES RECEIPT.) OUR PRODUCT IS INSPECTED TO ENSURE IT IS IN GOOD CONDITION. IF YOUR FURNITURE APPEARS TO HAVE BEEN DAMAGED IN SHIPMENT OR YOU ARE IN NEED OF REPLACEMENT PARTS PLEASE CONTACT THE DEALER FROM WHOM YOU PURCHASED THE PRODUCT.

Instruction Sheet

SAVE ALL PACKAGING MATERIALS UNTIL PRODUCT IS FULLY ASSEMBLED. HARDWARE AND SMALL PIECES MAY NOT BE SEEN AND BE ACCIDENTALLY DISCARDED WITH PACKAGING MATERIALS.

FIGURE 1

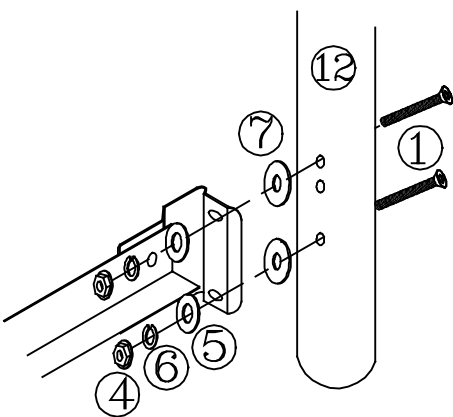
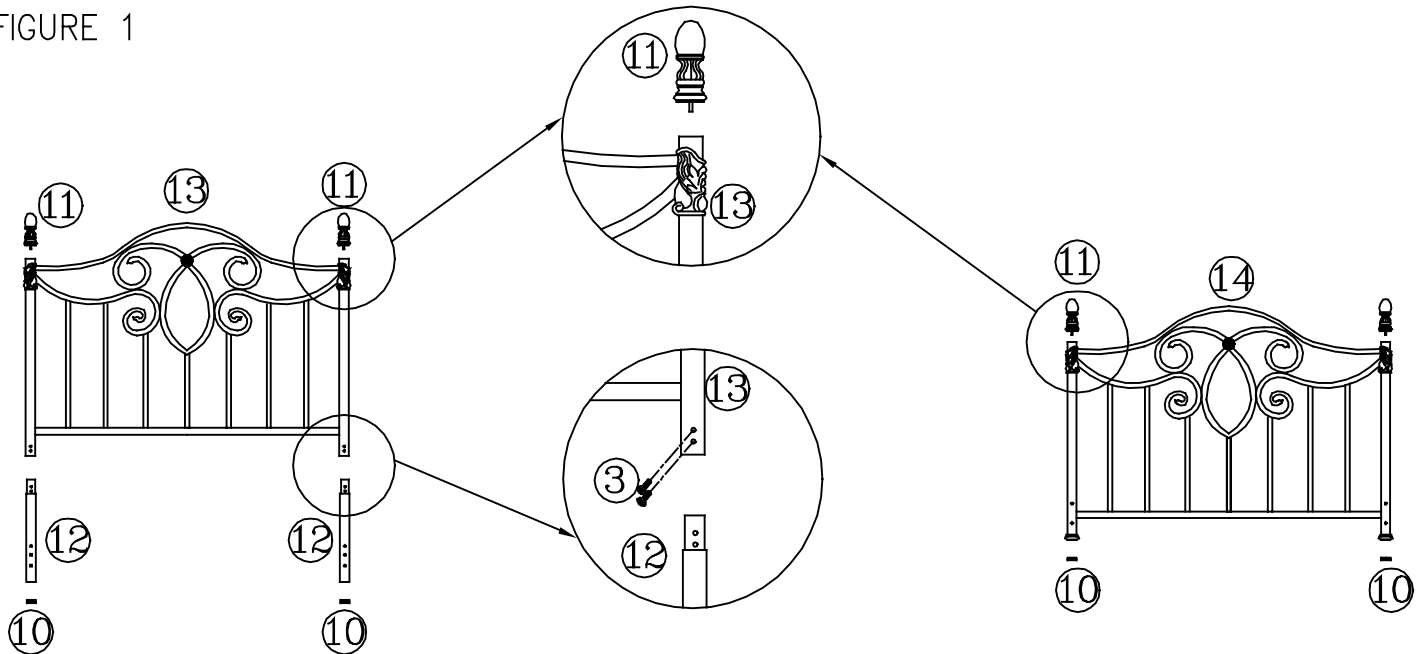

FIGURE 2

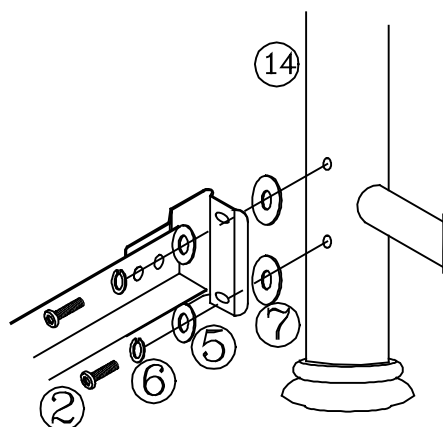

FIGURE 3

Step 1

- Insert plastic glide (10) into bottom of leg extensions (12).
- Align top reduction of extension legs (12) with bottom of headboard posts. (See Figure 1) Make sure the 3 holes on extension legs are perpendicular to headboard panel.
- Now carefully insert extension legs (12) into bottom of headboard (13) posts. Secure legs to headboard posts with screws (3). (See Figure 1)
- Screw in finials (11) into headboard and footboard posts.
- Insert plastic glide (10) into bottom of footboard (14) posts.

Step 2

- Place headboard and frame in desired location in room.
- Place 2 screws (1) through holes located in leg (12). (See Figure 2) Slide rubber washers (7) over screws (1).
- Align bed frame bracket over screws.
- Place a flat washer (5), a lock washer (6) and then a nut (4) on each screw. Hand-tighten, DO NOT TIGHTEN screws all the way.
- Repeat on other side of headboard.
- Tighten all screws securely using the Allen wrench (8) and open wrench (9).

Step 3

- Position footboard panel (14) and align holes in the post with holes in the frame bracket. (See figure 3)
- Place a lock washer (6) and a flat washer (5) on each screw (2). Insert through bracket, rubber washer (7) and into post. Hand-tighten, DO NOT TIGHTEN screws all the way.
- Repeat on other side of footboard panel.
- Tighten all screws securely using the Allen wrench (8).